

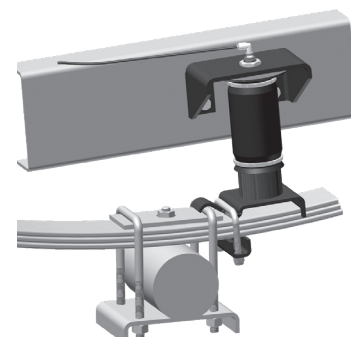

2008 APPLICATION GUIDE

Air Lift Adjustable Air Helper Springs

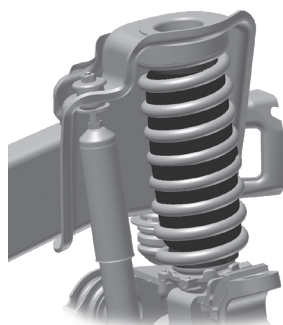
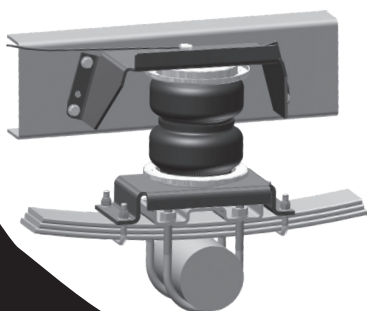

CHANGES MADE FOR JULY — SEPTEMBER VER.2 2008

	Year/Make/Model	Kit Number
PAGE 2	2005-2008 Acura MDX (New rear kit now available!)	60815
PAGE 2	2007-2008 Buick Enclave (New rear kit now available!)	60816
PAGE 4	2008-2008 Chrysler Town and Country (New rear kit now available!)	60814
PAGE 5	2008-2008 Dodge Caravan, Grand Caravan (New rear kit now available!)	60814
PAGE 6	2007-2008 GMC Acadia (New rear kit now available!)	60816
PAGE 7	2005-2008 Honda Odyssey (New rear kit now available!)	60815
PAGE 7	2005-2009 Honda Pilot (New rear kit now available!)	60815
PAGE 8	2007-2008 Jeep Wrangler (New rear kit now available!)	60817
PAGE 10	2007-2008 Saturn Outlook (New rear kit now available!)	60816
PAGE 10	2008-2008 Volkswagon Routan (New rear kit now available!)	60814

Start Year	End Year	Model	Drive	Notes	Front Kit	Front Repl.			Rear Kit	Rear Repl.		
Acura												
2005	2008	MDX	F&A	Fits front and all wheel drive					60815	60315	x	2
Buick- Car												
1982	1996	Century	FWD	Including station wagon					60797	60297	x	1
1964	1966	Deluxe, Custom, Skylark, Sport Wagon							60750	60250	x	1
1967	1972	Deluxe, Special, Skylark, Gran Sport		Excluding station wagon					60744	60244	x	1
1985	1996	Electra & Park Avenue	FWD	Excluding station wagon					60798	60298	x	1
1965	1984	Electra, Centurion, Wildcat, LeSabre		Excluding Estate Wagon					60755	60255	x	1
1977	1990	Estate Wagon							60755	60255	x	1
1985	1985	LeSabre	RWD						60755	60255	x	1
1986	1999	LeSabre	FWD	Excluding station wagon					60798	60298	x	1
2000	2005								60776	60276	x	1
1997	2005	Park Avenue							60776	60276	x	1
1973	1987	Regal, Century, Gran Sport, Luxus	RWD	Including station wagon					60733	60233	x	1
1979	1985	Riviera							60783	60283	x	1
1995	1999								60776	60276	x	1
1991	1996	Roadmaster Estate Wagon & Sedan							60755	60255	x	1
1985	1996	Skylark							60789	60289	x	1
Buick- Truck/SUV												
2007	2008	Enclave	F&A	Fits front and all wheel drive					60816	60316	x	2
Cadillac- Car												
1965	1993	All Rear Wheel Drive Models							60755	60255	x	1
1985	1993	Coupe Deville, Sedan Deville, Fleetwood							60798	60298	x	1
1985	1993	Touring Sedan	FWD						60798	60298	x	1
Cadillac- Truck/SUV												
2000	2000	Escalade 4-Door Only	2&4						59518	50259		2
2002	2007	Escalade, Escalade XL	2&4	Will not fit factory-installed auto-leveling option on 2007 models					60769	60269	x	1
Chevrolet- Car												
1988	1996	Beretta, Corsica							60789	60289	x	1
1982	2002	Camaro, Z28							60797	60297	x	1
1971	1996	Caprice, Impala		Excluding 94-96 SS models					60755	60255	x	1
1977	1996	Caprice, Impala Station Wagons							60755	60255	x	1
1965	1970	Caprice, Impala, Bel Air, Biscayne		Including station wagons					60736	60236	x	1
1982	1994	Cavalier		Including station wagons					60789	60289	x	1
1982	1990	Celebrity		Including station wagons					60797	60297	x	1
1964	1966	Chevelle, El Camino							60750	60250	x	1
1973	1983	Chevelle, Malibu, Laguna		Including station wagons					60733	60233	x	1
1967	1972	Chevelle, Malibu, SS, '300' Deluxe, Monte Carlo		Excluding station wagons					60744	60244	x	1
1967	1987	El Camino							60733	60233	x	1
1994	1996	Impala Sedan, SS							60786	60286	x	1
2004	2006	Malibu, Malibu Max							60776	60276	x	1
1973	1988	Monte Carlo		Excluding SS					60733	60233	x	1
1984	1988	Monte Carlo SS							60744	60244	x	1
Chevrolet- Truck/SUV												
2002	2008	Avalanche 1500	2&4	Will not fit factory-installed auto-leveling option					60769	60269	x	1
2002	2006	Avalanche 2500	4WD	Requires 6" between the tire and frame.					59526	50256		2
1969	1991	Blazer	4WD	Requires 6" between the tire and frame on rear kit.	59612	50272		3	59501	50203		2
1973	1991		2WD	Requires 6" between the tire and frame on rear kit.	81560	81260	x	1	59501	50203		2
1992	1997	Blazer, Tahoe 2 Door Only	4WD						59518	50259		
1973	1987	C-10 1/2 Ton Pickup	2WD		81560	81260	x	1	59527	50203		2
				For heavy loads or commercial use; Requires 8" between the tire and frame					57215	50201		2
1988	1998	C-1500 1/2 Ton Pickup Extended Cab	2WD	Requires 6" between the tire and frame.					59501	50203		2
				For heavy loads or commercial use					57128	50252		2
1988	1998	C-1500 1/2 Ton Pickup Regular & Crew Cab	2WD	Not extended cab; Requires 6" between the tire and frame					59501	50203		2
				For heavy loads or commercial use; Not extended cab; With axle to frame dimension of 7.25" or less use kit #57128					57216	50201		2
1973	1987	C-20, C-30 3/4 & 1 Ton Pickup	2WD	Requires 8" between the tire and frame.	81560	81260	x	1	57215	50201		2

Don't see a vehicle listed?

Call (800) 248-0892 to request.

No frame drilling required.

Install time (by hour)





Start Year	End Year	Model	Drive	Notes	Front Kit	Front Repl.			Rear Kit	Rear Repl.		
1988	2000	C-2500 3/4 Ton Pickup	2WD	With axle to frame dimension of 7.25" or less use kit #57128					57216	50201		2
1988	2000	C-3500 1 Ton	2WD	Under 11,000 GVWR; Excl. 4" rear axle housing; With axle to frame dimension of 7.25" or less use kit #57128					57216	50201		2
2004	2008	Colorado Z71	2&4						59539	50203	x	1
2004	2008	Colorado Z85	4WD						59539	50203	x	1
2004	2006	Colorado Z85 & ZQ8	2WD						59546	50254	x	1
2005	2006	Equinox	2&A	Fits All Wheel Drive					60727	60227	x	1
1989	2004	Geo-Tracker 2 Door	4WD						60793	60293	x	1
1973	1987	K-10 1/2 Ton Pickup	4WD	Requires 6" between the tire and frame	59612	50272		3	59501	50203		2
				For heavy loads or commercial use; Requires 8" between the tire and frame					57237	50201		2
1988	1998	K-1500 1/2 Ton Pickup	4WD	Requires 6" between the tire and frame					59501	50203		2
				For heavy loads or commercial use; With axle to frame dimension of 7.25" or less use kit #57128					57216	50201		2
1973	1987	K-20, K-30 3/4 & 1 Ton Pickup	4WD	Requires 8" between the tire and frame.	59612	50272		3	57237	50201		2
1988	2000	K-2500 3/4 Ton Pickup	4WD	With axle to frame dimension of 7.25" or less use kit #57128					57216	50201		2
1988	2000	K-3500 1 Ton	4WD	Under 11,000 GVWR; Except 4" rear axle housing; With axle to frame dimension of 7.25" or less use kit #57128					57216	50201		2
1982	2000	S-10 Blazer	2WD	2-Door only					59535	50256		2
1982	2005		4WD	2-Door only					59535	50256		2
1995	2004	S-10 Blazer	2&4	4-Door only					59536	50254		2
1994	2004	S-10 Pickup	4WD	All models without track bars					59531	50259		2
1982	2003		2WD	Without sport suspension					59529	50202		2
1983	1993		4WD						59529	50202		2
2000	2003	S-10 Pickup Xtreme/or with S-10 Sport Suspension	2WD						59535	50256		2
1999	2007	Silverado 1500 Classic GMT 800 series	2&4	Requires 6" between the tire and frame					59501	50203		2
2007	2008	Silverado 1500 GMT 900 series	2&4	Fits 68.4" and 78" bed lengths only					59565	50203	x	1
2001	2005	Silverado 1500 HD	2&4	Requires 6" between the tire and frame					59501	50203		2
				For heavy loads or commercial use					57250	50201	x	2
1999	2004	Silverado 2500 3/4 Ton Pickup	2&4	Except 2500 HD; Will not fit with Quadrateer					57250	50201	x	2
2001	2008	Silverado 2500 HD & 3500 1 Ton Pickup	2&4	Except comm. cab & chassis; Will not fit with Quadrateer					57275	50290	x	2
1973	1991	Suburban	2WD	May require exhaust modification	81560	81260	x	1	57221	50201		2
			4WD	May require exhaust modification	59612	50272		3	57221	50201		2
2000	2008	Suburban 1500 1/2 Ton	2&4	With coil springs; Will not fit factory-installed auto-leveling option					60769	60269	x	1
1992	1999								59518	50259		2
1992	1999	Suburban 2500 3/4 Ton	2WD						57129	50252		2
			4WD						57217	50201		2
2000	2008		4WD	With leaf springs; Requires 6" between the tire and frame					59526	50256		2
1995	2000	Tahoe 4 Door Only	2&4	With leaf springs rear					59518	50259		2
2000	2008		2&4	With coil springs; Will not fit factory-installed auto-leveling option					60769	60269	x	1
2002	2008	Trailblazer	4WD	Except factory air spring option					60779	60279	x	1
Chevrolet- Van												
1985	1995	Astro Van		All models with mono-leaf suspensions; may require exhaust modification					59504	50272		2
1995	2005			All models with steel multi-leaf suspension					59521	50269		2
1996	2002	Express G-1500 1/2 Ton Van							59526	50256		2
1996	2008	Express G-2500 Heavy Duty		Over 7,300 GVWR					57205	50252		2
1996	2002	Express G-2500 Light Duty		7,300 GVWR and under					59526	50256		2
1970	1995	G-10 1/2 Ton Van		59526 may not fit with rear air or heat	81560	81260	x	1	59526	50256		2

No frame drilling required.

Install time (by hour)

Don't see a vehicle listed?

Call (800) 248-0892 to request.





Start Year	End Year	Model	Drive	Notes	Front Kit	Front Repl.			Rear Kit	Rear Repl.		
1970	1995	G-20, G-30 3/4 & 1 Ton Van			81560	81260	x	1	57105	50284		2
1998	2004	G-3500 Commercial Chassis							57245	50252	x	2
1996	2008	G-3500 Passenger Van Only							57205	50252		2
1990	1996	Lumina APV Van							60751	60251	x	1
1997	2005	Venture							60748	60248	x	1
Chrysler- Car												
1990	1994	Imperial, New Yorker, 5th Avenue, Landua & Salon							60776	60276	x	1
1982	1995	LeBaron, LeBaron G.T.S., TC by Maserati		Including LeBaron GTS station wagon					60776	60276	x	1
1984	1989	New Yorker, Town & Country							60776	60276	x	1
2001	2006	PT Cruiser							60788	60288	x	1
Chrysler- Van												
1984	2000	Town & Country		Except all wheel drive; no fit with rear air/heat lines behind axle					59520	50254		2
2001	2003			Except all wheel drive					59560	50254		2
2005	2006			Except all wheel drive					59547	50254		2
2007	2007			No fit due to suspension design change								
2008	2008		2WD						60814	60314	x	2
Dodge- Car												
1982	1994	400, 600 Daytona, Lancer							60776	60276	x	1
1987	1994	Shadow							60776	60276	x	1
1990	1994	Spirit & Dynasty							60776	60276	x	1
Dodge- Truck/SUV												
1969	1993	D-150 1/2 Ton Pickup, W-100, 150 1/2 Ton Pickup	2&4	Requires 6" between tire and frame					59501	50203		2
				For heavy loads or commercial use; Requires 8" between tire and frame					57215	50201		2
1969	1993	D-250 3/4 and 1 Ton Pickup	2&4	Requires 8" between tire and frame					57215	50201		2
1987	2002	Dakota	2WD						59508	50203		2
1987	2004		4WD	Requires 6" between tire and frame					59501	50203		2
2003	2004		2WD						59528	50202		2
2005	2008		2&4						59555	50203		2
2000	2001	Dakota RT	2WD	Requires 6" between tire and frame					59501	50203		2
1998	2002	Durango	4WD						59529	50202		2
2001	2002		2WD						59503	50208		2
2003	2004		4WD	With leaf springs					59532	50254		2
2004	2008		4WD	With coil springs					60808	60308	x	1
1994	2001	Ram 1500 1/2 Ton Pickup	2&4	Requires 6" between tire and frame. Front kit fits 2WD only.	80765	80265	x	1	59501	50203		2
				For heavy loads or commercial use; Requires 8" between tire and frame					57215	50201		2
2002	2008		2&4	Requires 6" between tire and frame					59551	50203		2
2003	2008	Ram 2500	2WD						57297	50294	x	2
			4WD						57295	50293	x	2
1994	2002	Ram 2500 3/4 Ton Pickup	2&4	Requires 8" between tire and frame; Front kit fits 2WD only	80765	80265	x	1	57215	50201		2
2003	2008	Ram 3500	2WD	Single and dual wheel					57297	50294	x	2
			4WD	Single and dual wheel					57295	50293	x	2
1994	2002	Ram 3500 1 Ton Pickup	2&4	Except comm. cab & chassis; Requires 8" between tire and frame; Front kit fits 2WD only	80765	80265	x	1	57215	50201		2
1979	1993	Ram 50	2WD						59503	50208		2
1974	1993	Ramcharger	2&4	Requires 6" between tire and frame					59501	50203		2
2004	2006	SRT-10	2WD	With leaf springs under the axle only; Will fit custom truck manufactured from Dodge with Viper motor and leaf springs under the axle only--use standard kit for all trucks with leaf springs above the axle					59201	50261	x	1
1969	1993	W-250 3/4 and 1 Ton Pickup	2&4	Requires 8" between tire and frame					57215	50201		2
1969	1993	W-350 1 Ton Pickup		Requires 8" between tire and frame					57215	50201		2

Don't see a vehicle listed?

Call (800) 248-0892 to request.

 No frame drilling required.

 Install time (by hour)

Start Year	End Year	Model	Drive	Notes	Front Kit	Front Repl.			Rear Kit	Rear Repl.			
Dodge- Van													
1971	2004	B-100, 150, 1500 1/2 Ton Van							57105	50284		2	
1971	2004	B-200, 250, 300, 2500, 3500 1/2, 3/4 & 1 Ton Van							57105	50284		2	
2001	2003	Caravan, Grand Caravan		Except all wheel drive					59560	50254		2	
1984	2000			Except all wheel drive; no fit with rear air/heat lines behind axle					59520	50254		2	
2005	2006			Except all wheel drive					59547	50254		2	
2007	2007			No fit due to suspension design change									
2008	2008			2WD					60814	60314	x	2	
2003	2007	Freightliner Sprinter 2500 SRW		Single rear wheel					57147	50252		1	
Ford- Car													
1988	2006	Crown Victoria							60798	60298	x	1	
1983	1987	Crown Victoria, Country Squire							60769	60269	x	1	
2000	2006	Focus Sedan		Excluding station wagon					60723	60223	x	1	
2000	2006	Focus Station Wagon							60724	60224	x	1	
1979	2004	Mustang							60797	60297	x	1	
1986	2005	Taurus Station Wagon							60776	60276	x	1	
1992	1997	Thunderbird							60776	60276	x	1	
1989	1991								60789	60289	x	1	
Ford- Truck/SUV													
1980	1996	Bronco	4WD	Requires 6" between tire and frame	80590	80290	x	2	59501	50203		2	
1983	1990	Bronco II	4WD	Requires 6" between tire and frame	80777	80277	x	2	59501	50203		2	
2001	2008	Escape	2&4						60796	60296	x	1	
2000	2004	Excursion	2WD		80590	80290	x	2	57132	50252	x	2	
2000	2005		4WD			57154	50252		2	57340	50251		2
1997	2002	Expedition	4WD						61792	61292	x	1	
1991	1994	Explorer	4WD		80777	80277	x	2	59506	50254		2	
1995	1997		2WD	Without automatic ride control option						59514	50260		2
1995	2001		4WD	Without automatic ride control option						59514	50260		2
2002	2008			No fit due to suspension design change									
1998	2001	Explorer Sport	4WD						59514	50260		2	
2001	2005	Explorer Sport Trac	4WD						59534	50262		2	
1968	1996	F-100, 150 1/2 Ton Pickup	2WD	Requires 6" between tire and frame	80590	80290	x	2	59501	50203		2	
					For heavy loads or commercial use; Requires 8" between tire and frame					57215	50201		2
1966	1979	F-100, 150 1/2 Ton Pickup	4WD	Requires 6" between tire and frame	80523	80223		2	59501	50203		2	
					For heavy loads or commercial use; Requires 8" between tire and frame					57215	50201		2
1980	1996	F-100, 150 1/2 Ton Pickup	4WD	Requires 6" between tire and frame	80590	80290	x	2	59501	50203		2	
					For heavy loads or commercial use; Requires 8" between tire and frame					57215	50201		2
2004	2008	F-150 1/2 Ton Pickup	2&4	New body, excludes Heritage models					59544	50270	x	1	
1997	2004	F-150 including Heritage	2&4	With 5th wheel hitch; Requires 6" between tire and frame					59542	50203		2	
1997	2004	F-150 including Heritage 1/2 Ton Pickup	2&4	Including Lightning & Harley Davidson; Requires 6" between tire and frame; Short box, extended cab, with fifth wheel hitch use kit #59542 instead					59501	50203		2	
1969	1979	F-250 3/4 Ton Pickup	2WD	Under 7,500 GVWR; Requires 8" between tire and frame	80590	80290	x	2	57215	50201		2	
1970	1979		2WD	7,500 GVWR & Over; Requires 8" between tire and frame	80531	80231	x	2	57215	50201		2	
1980	1996		2WD	Requires 8" between tire and frame	80590	80290	x	2	57215	50201		2	
1980	1997		4WD	97 Heavy Duty Over 8,600 GVWR Only; Requires 8" between tire and frame	59611	50203		3	57215	50201		2	
1997	1997	F-250 Heavy Duty 3/4 Ton Pickup	2WD	7,500 GVWR & Over; Requires 8" between tire and frame	80590	80290	x	2	57215	50201		2	
1997	1998	F-250 Light Duty 3/4 Ton Pickup	2&4	Under 7,500 GVWR				2	57215	50201		2	

 No frame drilling required.

 Install time (by hour)

Don't see a vehicle listed?

Call (800) 248-0892 to request.





Start Year	End Year	Model	Drive	Notes	Front Kit	Front Repl.			Rear Kit	Rear Repl.		
1999	2004	F-250 Super Duty 3/4 Ton Pickup	2WD	8,800 GVWR; Requires 8" between tire and frame	80590	80290	x	2	57215	50201		2
1999	2007	F-250 & F-350	2&4	Only fits B&W hitch part #1105 and #1199R in 49" position with minor modifications to both B&W and Air Lift's upper brackets; Front kit fits 4WD only	80537	80237	x	1	57291	50201	x	2
2005	2008		2&4	With Reese 5th wheel hitch-except Reese "Signature Series" or Reese hitches with custom rail kit installations. Front kit fits 4WD only.	80537	80237	x	1	57212	50201		2
1999	2004	F-250 & F-350 Super Duty 3/4 & 1 Ton Pickup	2&4	Requires 8" between tire and frame; Front kit fits 4WD only	57154	50252		2	57215	50201		2
1971	2004	F-250 & F-350 Super Duty	2&4	With Reese 5th wheel hitch					57298	50201		2
2005	2008		2&4	With Reese 5th wheel hitch-except Reese "Signature Series" or Reese hitches with custom rail kit installations					57212	50201		2
2005	2008	F-250 & F-350 Underframe Mounting w/ Fifth Wheel Hitch Applications	2&4	Fits single rear wheel (SRW) and dual rear wheel (DRW) models. Will fit most side-mount fifth wheel hitch applications.					57394	50201	x	3
1970	1979	F-350 1 Ton Pickup	2WD	Requires 8" between tire and frame	80531	80231	x	2	57215	50201		2
1980	1997		4WD	Excl. Super HD chassis; Requires 8" between tire and frame; Will not fit with stabilizer bar	59611	50203		3	57215	50201		2
			2WD	Requires 8" between tire and frame	80590	80290	x	2	57215	50201		2
1999	2004	F-350 Super Duty 1 Ton Pickup	2WD	11,200 GVWR & Under; Requires 8" between tire and	80590	80290	x	2	57215	50201		2
1994	2004	F-450, F-550 Commercial Vehicle typically sold as cab and chassis (straight frame)	2&4	Requires 9" between tire and frame	57154	50252	x	2	57345	50229		2
2005	2008		2&4	Requires 9" between tire and frame	80539	80239		2	57345	50229		2
2008	2008	F-450 Pickup	2&4	Front kit fits 4WD only	80537	80237	x	1	57347	50201	x	1
1983	1994	Ranger	4WD		80777	80277	x	2	59516	50259		2
1995	1997		2WD		80777	80277	x	2	59516	50259		2
1998	2008		4WD		80754	80254	x	2				
			2&4						59516	50259		2
Ford- Van												
1986	1997	Aerostar							60738	60238	x	1
1996	2008	E-150 1/2 Ton Van		Requires 6" between tire and frame	80545	80245	x	1	59526	50256		2
1975	2006	E-250, E-350 3/4 & 1 Ton Van			80545	80245	x	1	57125	50284		2
2004	2007	Freestar							60702	60202	x	1
1994	2003	Windstar							60799	60299	x	1
GMC- Truck/SUV												
2007	2008	Acadia	F&A	Fits front and all wheel drive					60816	60316	x	2
1988	1998	C & K -1500 & K-1500 1/2 Ton Pickup Regular Cab	2&4	For heavy loads or commercial use; With axle to frame dimension of 7.25" or less use kit #57128					57216	50201		2
				Requires 6" between tire and frame					59501	50203		2
1988	2000	C & K-2500 3/4 Ton Pickup	2&4	With axle to frame dimension of 7.25" or less use kit #57128					57216	50201		2
1973	1987	C-1500 1/2 Ton Pickup	2WD		81560	81260	x	1	59527	50203		2
					For heavy loads or commercial use; Requires 8" between tire and frame				57215	50201		2
1988	1998	C-1500 1/2 Ton Pickup Extended Cab	2WD	Requires 6" between tire and frame					59501	50203		2
					For heavy loads or commercial use				57128	50252		2
1973	1987	C-2500 3/4 Ton Pickup	2WD	Requires 8" between tire and frame	81560	81260	x	1	57215	50201		2
1968	1987	C-3500 1 Ton Pickup	2WD	Requires 8" between tire and frame	81560	81260	x	1	57215	50201		2
1988	2000		2&4	Under 11,000 GVWR; Except 4" rear axle housing; With axle to frame dimension of 7.25" or less use kit #57128					57216	50201		2
2004	2008	Canyon Z71	2WD						59539	50203		1
2004	2008	Canyon Z85	2WD						59546	50254	x	1
			4WD						59539	50203	x	1
2002	2008	Envoy	4WD	Except factory air spring option					60779	60279	x	1

Don't see a vehicle listed?

Call (800) 248-0892 to request.

No frame drilling required.

Install time (by hour)





Start Year	End Year	Model	Drive	Notes	Front Kit	Front Repl.			Rear Kit	Rear Repl.		
1969	1991	Jimmy	4WD	Requires 6" between tire and frame	59612	50272		3	59501	50203		2
1973	1991		2WD	Requires 6" between tire and frame	81560	81260	x	1	59501	50203		2
1973	1987	K-1500 1/2 Ton Pickup	4WD	For heavy loads or commercial use; Requires 8" between tire and frame					57237	50201		2
				Requires 6" between tire and frame	59612	50272		3	59501	50203		2
1973	1987	K-2500 3/4 Ton Pickup	4WD	Requires 8" between tire and frame	59612	50272		3	57237	50201		2
1973	1987	K-3500 1 Ton Pickup	4WD	Requires 8" between tire and frame	59612	50272		3	57237	50201		2
1982	2000	S-15 Jimmy 2 Door Only	2WD						59535	50256		2
1983	2002		4WD						59535	50256		2
1995	2002	S-15 Jimmy 4 Door Only	2&4						59536	50254		2
1983	1993	S-15 Pickup, Sonoma	4WD	All models					59529	50202		2
1982	2003		2WD						59529	50202		2
1994	2004		4WD	All models without track bar					59531	50259		2
1999	2007	Sierra 1500 Classic GMT 800 series	2&4	Requires 6" between tire and frame					59501	50203		2
2007	2008	Sierra 1500 GMT 900 series	2&4	Fits 68.4" and 78" bed lengths only					59565	50203	x	1
2001	2008	Sierra 1500 HD	2&4	Requires 6" between tire and frame					59501	50203		2
				For heavy loads or commercial use					57250	50201	x	2
1999	2004	Sierra 2500 3/4 Ton Pickup	2&4	Except 2500 HD; Will not fit with Quadrateer					57250	50201	x	2
2001	2008	Sierra 2500 HD & 3500 1 Ton Pickup	2&4	Except comm. cab & chassis; Will not fit with Quadrateer					57275	50290	x	2
1973	1991	Suburban	2WD	May require exhaust modification	81560	81260	x	1	57221	50201		2
			4WD	May require exhaust modification	59612	50272		3	57221	50201		2
1992	1999	Suburban 1500 1/2 Ton	2&4						59518	50259		2
1992	1999	Suburban 2500 3/4 Ton	2WD						57129	50252		2
			4WD						57217	50201		2
1992	1997	Yukon 2 Door Only	4WD						59518	50259		2
1995	2000	Yukon 4 Door	2&4	With leaf springs					59518	50259	x	2
2000	2008	Yukon or Yukon XL 1500	2&4	With coil springs; Will not fit factory-installed auto-leveling option					60769	60269	x	1
2000	2008	Yukon XL 2500 3/4 Ton	4WD	With leaf springs; Requires 6" between tire and frame					59526	50256		2
GMC- Van												
1970	1995	G-15 1/2 Ton Van		Requires 6" between tire and frame; May not fit with rear air/heat	81560	81260	x	1	59526	50256		2
1970	1995	G-25, G-35 3/4 & 1 Ton Van			81560	81260	x	1	57105	50284		2
1985	1995	Safari Van		With mono-leaf suspension; May require exhaust modification					59504	50272		2
1995	2004			With steel multi-leaf suspensions					59521	50269		2
1996	2002	Savana G-1500 1/2 Ton Van		Requires 6" between tire and frame					59526	50256		2
1996	2002	Savana G-2500		Requires 6" between tire and frame; 7,300 GVWR and under					59526	50256		2
1996	2008	Savana G-2500 & G-3500		Passenger van only; Requires 6" between tire and frame					57205	50252		2
Honda												
1999	2005	Odyssey							60740	60240	x	1
2005	2008		F&A	Fits front and all wheel drive					60815	60315	x	2
1998	2002	Passport							60797	60297	x	1
2003	2005	Pilot							60740	60240	x	1
2005	2009		F&A	Fits front and all wheel drive					60815	60315	x	2
Hummer												
2003	2008	Hummer H2	4WD						60769	60269	x	1
2006	2008	Hummer H3	4WD						59563	50203		1
Hyundai												
2001	2005	Santa-Fe							60727	60227	x	1
Infiniti												
1997	2004	QX4	4WD						60742	60242	x	1

 No frame drilling required.

 Install time (by hour)

Don't see a vehicle listed?

Call (800) 248-0892 to request.

Start Year	End Year	Model	Drive	Notes	Front Kit	Front Repl.			Rear Kit	Rear Repl.		
Isuzu												
1990	1993	Amigo							59503	50208		2
1998	1999								60797	60297	x	1
2002	2004	Axion							60797	60297	x	1
1980	1994	Pickup	2WD						59529	50202		2
1995	1995								59502	50255		2
1996	2000	Pickup, Hombre	2WD						59529	50202		2
1991	1994	Rodeo							59503	50208		2
1998	2003								60797	60297	x	1
1992	2002	Trooper							60783	60283	x	1
1985	1991	Trooper II							59503	50208		2
1999	1999	Vehicross							60797	60297	x	1
Jeep/Eagle												
1972	1986	CJ Series & Scrambler							59503	50208		2
1986	1993	Comanche			80702	80202	x	2	59503	50208		2
2006	2008	Commander							60811	60311	x	1
1984	1991	Custom & Grand Wagoneer							59507	50269		2
1992	1993	Eagle Summit		Station wagon only					60776	60276	x	1
1999	2004	Grand Cherokee							60754	60254	x	1
2005	2008		4WD	Does not fit SRT models					60813	60313	x	1
1992	1998	Grand Wagoneer, Grand Cherokee		Except "Up Country" models	80702	80202	x	2	60795	60295	x	1
2002	2007	Liberty	2&4						60777	60277	x	1
1992	2002	Wagoneer, Cherokee		Also fits Sport model					59507	50269		2
1997	2006	Wrangler (including Rubicon)			80702	80202	x	2	60811	60311	x	1
2007	2008		2&4						60817	60317		1
1984	1991	XJ-Wagoneer, XJ-Cherokee, Pioneer			80702	80202	x	2	59507	50269		2
Kia												
2002	2005	Sedona Van							60763	60263	x	1
2003	2006	Sorento							60792	60292	x	1
1997	2003	Sportage							60752	60252	x	1
LandRover												
1994	1997	Defender		USA only					61741	61241	x	2
Lexus												
1996	2002	LX 450-470							60728	60228	x	1
Lincoln- Car												
1982	1988	Continental		Excl. vehicles w/factory air suspension					60783	60283	x	1
1984	1987	Mark VII		Excl. vehicles w/factory air suspension					60783	60283	x	1
1980	1989	Towncar							60769	60269	x	1
Lincoln- Truck												
2005	2008	Mark LT							59544	50270	x	1
Mazda												
1989	1995	MPV Van							60759	60259	x	1
1996	1998								60776	60276	x	1
1991	1994	Navajo	4WD		80777	80277	x	1	59506	50254		2
1972	1993	Pickup	2&4	All models					59503	50208		2
1994	1997		2WD	All models	80777	80277	x	1	59516	50259		2
			4WD	All models	80754	80254	x	1	59516	50259		2
1998	2008		2&4	All models					59516	50259		2
2001	2008	Tribute	2&4						60796	60296	x	1
Mercury- Car												
1989	1991	Cougar							60789	60289	x	1
1992	1997								60776	60276	x	1
1998	2006	Grand Marquis							60798	60298	x	1
1983	1997	Grand Marquis, Colony Park		Including station wagon					60769	60269	x	1
1986	2005	Sable Station Wagon							60776	60276	x	1
Mercury- Van/SUV												
2004	2007	Monterey							60702	60202	x	1
1996	2001	Mountaineer	2&4	Without automatic ride control option					59514	50260		2
1993	2002	Villager							59510	50255		2
Mitsubishi												
1992	1993	Expo							60776	60276	x	1

Don't see a vehicle listed?

Call (800) 248-0892 to request.

 No frame drilling required.

 Install time (by hour)





Start Year	End Year	Model	Drive	Notes	Front Kit	Front Repl.			Rear Kit	Rear Repl.		
1990	2000	Montero							60747	60247	x	1
1997	1998	Montero Sport	4WD						59503	50208		2
1999	2004								60747	60247	x	1
1983	1993	Pickup	2WD						59529	50202		2
2006	2008	Raider	2&4						59555	50203		2
Nissan												
1998	1998	Frontier	2WD						59503	50208		2
1998	2000		4WD						59506	50254		2
2003	2007	Murano	2&4						60774	60274	x	1
1987	1995	Pathfinder	4WD						60783	60283	x	1
1996	2004								60742	60242	x	1
2005	2008								60810	60310	x	1
2004	2006	Pathfinder Armada	4WD						60807	60307	x	1
1969	1997	Pickup	2WD						59529	50202		2
			4WD						59506	50254		2
1993	2002	Quest							59510	50255		2
2004	2007		2WD						60806	60306	x	1
2004	2008	Titan	2&4						59554	50256		1
2005	2007	Xterra	4WD						59562	50259		1
Oldsmobile- Car												
1992	1998	Achieva							60789	60289	x	1
1995	2004	Aurora							60776	60276	x	1
1977	1993	Custom Cruiser Station Wagon							60755	60255	x	1
1984	1995		FWD						60797	60297	x	1
1964	1966	Cutlass		Including station wagon and Vista Cruiser					60750	60250	x	1
1985	1991	Cutlass Calais	FWD						60789	60289	x	1
1982	1996								60797	60297	x	1
1973	1987	Cutlass, Cutlass Supreme, Calais		Excluding station wagon					60733	60233	x	1
1967	1972	Cutlass, F-85, 442		Excludign station wagon					60744	60244	x	1
1985	1999	Delta 88, 98, Regency	FWD						60798	60298	x	1
1996	1999	LS Sedan							60798	60298	x	1
Oldsmobile- SUV/Van												
1991	1994	Bravada							59503	50208		2
2002	2004			Except factory air spring option					60779	60279	x	1
1996	2001	Bravada, 4 Door		No fit for '97					59536	50254		3
1990	1996	Silhouette							60751	60251	x	1
1997	2004	Silhouette APV							60748	60248	x	1
Plymouth- Car												
1989	1995	Acclaim							60776	60276	x	1
1981	1994	Reliant							60776	60276	x	1
1987	1993	Sundance							60776	60276	x	1
Plymouth- Van												
1984	2000	Voyager, Grand Voyager		Except all wheel drive; no fit with rear air/heat lines behind axle					59520	50254		2
2001	2003			Except all wheel drive					59560	50254		2
Pontiac- Car												
1982	1991	6000							60797	60297	x	1
1987	1999	Bonneville	FWD						60798	60298	x	1
2000	2005								60776	60276	x	1
1982	2002	Firebird, Trans Am							60797	60297	x	1
1985	1998	Grand Am							60789	60289	x	1
1973	1982	Grand Am, Grand LeMans, LeMans		Including station wagon					60733	60233	x	1
1965	1968	Grand Prix							60733	60233	x	1
1969	1972								60744	60244	x	1
1973	1987								60733	60233	x	1
1982	1994	J-2000, Sunbird		Including station wagon					60789	60289	x	1
1988	1992	LeMans							60789	60289	x	1
1967	1972	LeMans, Tempest, GTO, GT37		Excluding station wagon					60744	60244	x	1
1987	1989	Safari Station Wagon							60755	60255	x	1
1964	1966	Tempest, GTO		Including station wagon					60750	60250	x	1





No frame drilling required.

Install time (by hour)

Don't see a vehicle listed?

Call (800) 248-0892 to request.

Start Year	End Year	Model	Drive	Notes	Front Kit	Front Repl.			Rear Kit	Rear Repl.		
Pontiac- Van												
1990	1996	Transport APV Van							60751	60251	x	1
1997	2005	Transport APV Van, Montana							60748	60248	x	1
Saturn												
2007	2008	Outlook	F&A	Fits front and all wheel drive					60816	60316	x	2
2002	2006	Vue							60727	60227	x	1
2007	2008			No fit due to suspension design change								
Suzuki												
1999	2005	Grand Vitara, Vitara, XL-7	4WD						60793	60293	x	1
1989	1998	Sidekick, 2 Door							60793	60293	x	1
Toyota- Truck/SUV												
1990	1995	4 Runner	4WD						60812	60312	x	1
1996	2002		2&4						60743	60243	x	1
2003	2008		4WD						60809	60309	x	1
1969	1995	Extended Cab Pickup	4WD						59517	50254		2
2007	2008	FJ Cruiser	4WD						60809	60309		2
1979	1990	Land Cruiser							59102	50272		2
1991	2006								60728	60228	x	1
1969	1995	Pickup	2WD						59502	50255		2
			4WD	Except extended cab					59502	50255		2
1996	2000	RAV4	2&4						60789	60289	x	1
2005	2008	Scion XB							60774	60274	x	1
2001	2007	Sequoia	2&4						60812	60312	x	1
1993	1998	T-100 Pickup	4WD						59503	50208		2
1993	1998	T-100 Pickup	2WD	All models					59502	50255		2
2005	2008	Tacoma	2WD	Will not fit Pre-Runner					59564	50256		1
1995	2004	Tacoma	2WD	All models					59503	50208		2
			4WD	All models					59537	50256		2
2005	2008		4WD	All models					59561	50254	x	1
2005	2006	Tacoma Pre-Runner	2WD	Axle below leaf spring					59561	50254	x	1
2000	2006	Tundra	2&4						59530	50291		1
2007	2008		2&4	May not work with some 5th wheel hitches					57299	50264	x	1
Toyota- Van												
1991	1996	Previa		All models					60739	60239		1
1998	2003	Sienna							60785	60285	x	1
2004	2008								60732	60232	x	1
Volkswagen												
1985	2003	EuroVan							60789	60289	x	1
2008	2008	Routan	2WD						60814	60314	x	2

Motorhome/RV/Step Van Applications											
Start Year	End Year	Model	Notes	Front Kit	Front Repl.			Rear Kit	Rear Repl.		
Chevrolet											
1970	1995	G-30 Class "C"		81560	81260	x	1	57105	50284		2
1998	2006	G-3500 Class "C"						57245	50252	x	2
1993	1995	GP-30 Cutaway Chassis		81560	81260	x	1	57203	50284	x	2
2004	2006	5500 Cutaway Chassis						57292	50329		2
2002	2006	W20/W22/W24 Class "A"	GVWR 20,000-24,000	57101	50252		1	57202	50201		2
2000	2003	P-32 Class "A"	18,000 GVWR only	81560	81260	x	1	57362	50229		2
1993	2002	P-30, P-32 Class "A"	Over 14,500 GVWR including Workhorse	81560	81260	x	1	57219	50201		2
1993	1998	P-30, P-32 Class "A"	Under 14,500 GVWR	81560	81260	x	1	57203	50284	x	2
1963	1992	P-30, P-32 Class "A"		81560	81260	x	1	57203	50284	x	2
Dodge											
1971	1994	B-350 Class "C"						57105	50284		2
1973	1982	M-300, M-400, M-500, M-600 Class "A"		57106	50252		2	57214	50211		2
Ford											
1996	2006	E-450 Super Duty Class "C"	14,050 and above GVWR; Under frame kit	80531	80231	x	2	57131	50201	x	2
			Side mount kit for maximum load & stability; Requires 8" between tire and frame- use #57131 if mounting area is obstructed; 14,050 and above GVWR; Under frame kit					57242	50251		
1975	2006	E-350 Class "C"		80545	80245	x	1	57125	50284		2
1998	2006	F-53 Class "A"	Does not fit 26,000 GVWR	57140	50252		2	57410	50229		2
1990	1997	F-53 Class "A"		57140	50252		2	57208	50201		2
Oshkosh/John Deer/Freightliner											
1987	1992	Class "A"	Front engine models only;	57106	50252		2				2
1991	1997	Class "A"	Pusher "X" chassis only					57224	50201		2
Toyota											
1986	1994	Micro Mini						57113	50252		2



Replacements for Firestone Motorhome Bags	No. on Firestone Bag	Firestone Part No.	Air Lift Part No.
Air Lift 2B7, 1/4" NPT Air Spring	224C	0335	50329
Air Lift 2B6 Extended, 1/4" NPT Air Spring	255C	6957	50309

SlamAir Applications for Lowered Vehicles



Start Year	End Year	Model	Drive	Notes	2" - 4" Rear Kit	Replacement Bag	5" - 6" Rear Kit	Replacement Bag
Chevrolet/GMC								
1988	1998	1/2 Ton Full Size Truck	2WD		59103	50254	59106BT	50203
1988	2000	3/4 Ton Truck	2WD	Classic Only	no fit	no fit	59202	50307
1988	2000	1 Ton Truck	2WD		no fit	no fit	59202	50307
1995	2004	Astro Van	2WD	Multi-leaf	59111	50254	no fit	no fit
1982	2002	Blazer, Jimmy, Bravada	2WD		59102	50272	no fit	no fit
1993	2008	Silverado/Sierra 1/2 Ton Pickup	2WD	Except 1500 HD	59103	50254	no fit	no fit
1999	2007	Silverado/Sierra GMT 800	2WD	Fits 4-6" drops only	59209	50266	59209	50266
2007	2008	Silverado/Sierra GMT 900	2WD	Fits 4-6" drops only; Does not fit long bed	59209	50266	59209	50266
1982	2004	S-10/Sonoma Pickup	2WD		59102*	50272	no fit	no fit
2000	2004	S-10 Pickup Extreme	2WD		59102*	50272	no fit	no fit
Ford								
1970	2004	1/2 Ton Full Size Truck	2WD	For 2004, fits Heritage model only	59103	50254	no fit	no fit
2004	2009	F-150	2WD	New body, excludes Heritage models	59210	50266	59210	50266
Dodge								
1969	2001	1/2 Ton Full Size Truck	2WD		59103	50254	no fit	no fit
2002	2008	1500	2WD	Fits 4-6" drops only	59113	50259	59113	50259
Toyota								
1969	1998	Pickup 2WD	2WD		59102*	50272	no fit	no fit
1995	2004	Tacoma 2WD	2WD		59102*	50272	no fit	no fit

*If top of leaf to bottom of the frame is less than 8.5" - use kit #59104

AirCell Applications - Front end load support for snow plow applications

Start Year	End Year	Model	Drive	Notes	Kit Number		
Chevrolet/GMC							
1988	2000	3/4 & 1 Ton	4WD	With stamped lower control arm	52100	x	1
1988	1998	1/2 Ton	4WD	Old body	52100	x	1
1992	1996	Tahoe/Full Size Blazer/Yukon/Suburban			52100	x	1
1996	2000	3/4 & 1 Ton	4WD	Old body; with stamped lower control arm	52110	x	1

Accessories

Model	Drive	Notes	Kit Number		
Lock-N-Lift Universal Air Spring Spacers					
Lock-N-Lift — 2" Lift	2&4	Includes all hardware; Does not fit RideControl; Not recommended for lifts above 6"	52130	x	1
Lock-N-Lift — 4" Lift	2&4	Includes all hardware; Does not fit RideControl; Not recommended for lifts above 6"	52140	x	1
Lock-N-Lift — 6" Lift	2&4	Includes all hardware; Does not fit RideControl; Not recommended for lifts above 6"	52150	x	1

Don't see a vehicle listed?

Call (800) 248-0892 to request.

 No frame drilling required.

 Install time (by hour)